

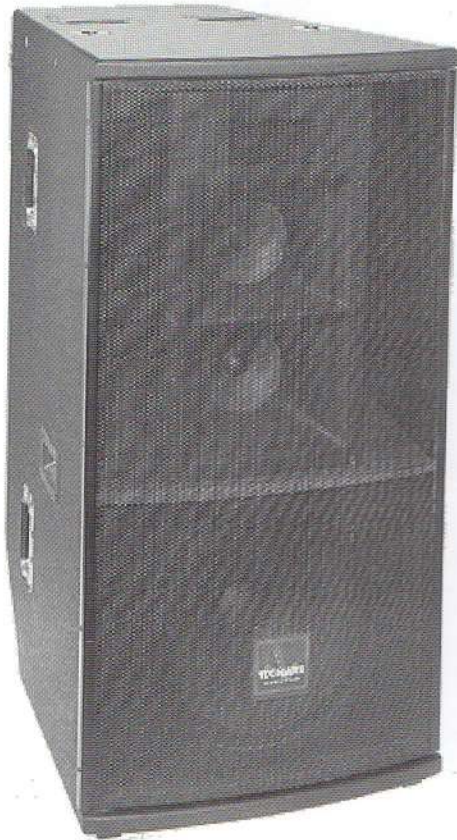

Tecnare **TS 1300**



Description:

TS1300 is a three way trapezoidal full range loudspeaker. It houses one 15" and one 12" loaded by a horn, two 6 1/2" also horn loaded and a 1" compression driver. This design is better recommended for short and mid throw applications. The system can be easily operated in 1, 2, or 3 way active, only moving a 3 position switch, that connects and disconnects an internal passive crossover. The low frequency section combines the deep low end bass response of a 15" driver with the aggressive fast punch of an specially developed 12". The mid band features a smooth, clean and natural response from 500 Hz to 4 KHz, given by two 6 1/2" transducers, far away from the harshness of a typical 2" compression driver. The remaining high frequency band is handled by a 1" compression driver coupled into a short exponential horn. This component is active and passively protected by two different protection circuits. The PSS (power switch sense) circuit allows signal passing through the driver until the moment before it can break. After switching off, it will automatically switch on when the signal through the driver is reduced to levels that won't damage the driver. Crafted from birch plywood, equipped with castors, handles, protection grille and flying hardware, the system is ideal for rental applications.

Applications:

The TS1300 can be used in the following installations:

- Mobile audio and rentals
- Live music installations
- Theater installation

Technical specifications:

| | |
|--------------------------------|--|
| Frequency Response (Hz) | 48 Hz-19 KHz \pm 3 dB |
| Power Handling (Watts) | Low-800 W RMS / Mid-300 W RMS / High-100 W RMS |
| Sensitivity | 103 dB (1 watt / 1 meter) |
| Nominal peak | 132 dB |
| Coverage angle | 90° horizontal 40° vertical |
| Crossover | Switchable 3, 2, or 1 way (active or passive); 400 Hz/1,5 KHz |
| Impedance | Low: 4 ohms, Mid: 16 ohms, High: 16 ohms |
| Drivers | Low: 1x15" + 1x12". Mid: 2x6 1/2". High: 1x1" + exponential horn |
| Connectors | 1x8 pin speakon + 1x4 pin speakon |
| Dimensions | Trapezoidal 108,5x56,6F/36Rx71 cm |
| Weight | 78 Kg |

FRONT

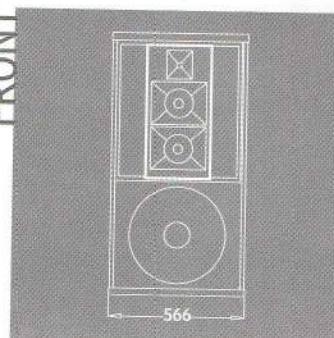

TOP

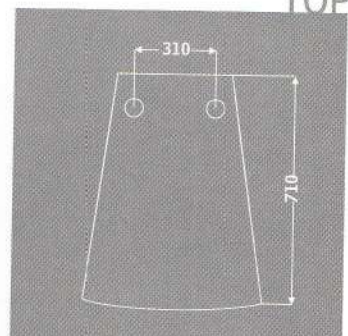

RIGHT

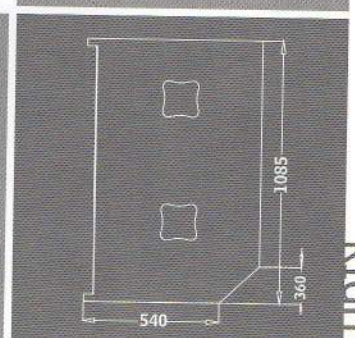

Tecnare **TS 1300**

D i a g r a m :
F r e q u e n c y r e s p o n s e c u r v e

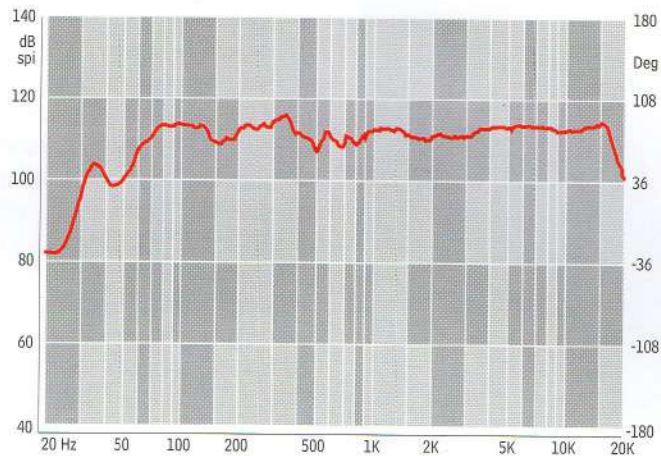

D i a g r a m :
H o r i z o n t a l p o l a r p a t t e r n

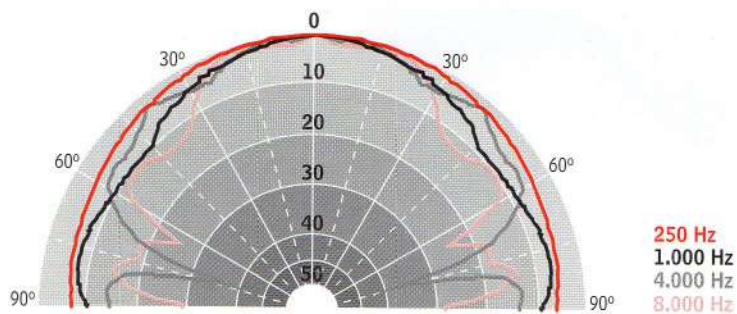

Is a™ designed and
manufactured in Spain by

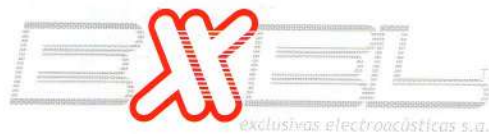

Pº Ind. Alparrache, nave 70 - 28600 NAVALCARNERO (Madrid) SPAIN
Phone: 34 91 8112563 Fax: 34 91 8112563

<http://www.tecnare.com>
e-mail: exel@tecnare.com